



# The Complete Utility Locating System™ Specification

## for the Water/Sewer Market

This specification provides the technical requirements necessary to ensure proper installation of tracer wire and related components for the purposes of locating both conductive and non-conductive underground water/sewer utilities. It recognizes that the first step in protecting underground utility assets is installing a quality, reliable locating system. This specification is based on best practices for underground utility locating.

### Materials

#### General

- All system components, including tracer wire, connectors, ground rods and access points, must be compatible. The component parts of the Copperhead® Complete Utility Locating System™ have been designed and engineered for compatibility to ensure end-to-end conductivity for the purpose of detecting underground utility assets.
- All tracer wire and tracer wire products shall be manufactured in the USA.
- All tracer wire shall have HDPE insulation for direct bury, color coded per APWA standard for the specific utility being marked.

#### Tracer wire

- Open Trench - Tracer wire shall be Copperhead® copper-clad steel 12-AWG High Strength with minimum 450 lb. break load, minimum 30 mil HDPE insulation thickness (1230\*-HS-\*\*).
- Directional Drilling/Boring - Tracer wire shall be Copperhead copper-clad steel 12-AWG Extra High Strength with minimum 1,150 lb. break load, minimum 45 mil HDPE insulation thickness (1245\*-EHS-\*\*).
- Pipe Bursting - Tracer wire shall be Copperhead 7x7 stranded copper-clad steel SoloShot™ Xtreme Strength with 4,700 lb. break load, minimum 50 mil HDPE insulation thickness (PBX-50\*-\*\*).

\* denotes color (B=blue, G=green, P=purple)

\*\* spool size (500', 1000', 2500')

#### Connectors

- All mainline tracer wires shall be interconnected at intersections, at mainline tees and mainline crosses. At tees, the three wires shall be joined using a single, three-way SnakeBite™ Locking Connector (LSC1230C). At crosses, the four wires shall be joined using two, three-way Copperhead SnakeBite™ Locking Connectors (LSC1230C) with a short jumper wire between them.
- Direct bury wire connectors shall include three-way lockable Copperhead SnakeBite™ Locking Connectors (LSC1230C) and Copperhead Mainline-to-Service Connectors (3WB-01) specifically manufactured for use in underground tracer wire installation. Connectors shall be

dielectric silicone filled to seal out moisture and corrosion and shall be installed in a manner as to prevent any uninsulated wire exposure.

- Non-locking, friction fit or taped connectors are prohibited.

## Grounding

- Tracer wire must be properly grounded at all dead-ends/stubs.
- Grounding of tracer wire shall be achieved by using a 1.5-lb, drive-in, magnesium Copperhead Ground Rod (ANO-12) with a minimum 20-foot, #12 red HDPE insulated copper-clad steel wire connected to the rod specifically manufactured for this purpose.

## Termination/Access

- All tracer wire termination points must provide a direct connection point to the tracer wire by a utility locate transmitter (above ground or at grade) specifically manufactured for lite duty, concrete/driveway, or roadway applications.
- All at-grade access points shall be appropriately identified with “sewer” or “water” on the cap and be color coded per American Public Works (APWA) standards.
- All two-terminal tracer wire access points must include a manually interruptible conductive/connective link between the terminal for the tracer wire connection and the terminal for the ground rod wire connection.
- All at-grade access points shall include an encapsulated magnet molded into the top portion of the tube, to allow for detection by a ferrous metal detector.
- All at-grade access points shall be supplied with anti-corrosion wax/gel to protect wires.
- Service laterals on *public* property – Tracer wire shall terminate at an approved at-grade, two-terminal Copperhead SnakePit® Lite Duty (LD14\*2T), Lite Duty Adjustable (LD14\*2T-ADJ), Lite Duty XL (LDXL36\*2T), or Concrete/Driveway (CD14\*2TP) Access Point located at the edge of the road right-of-way, and out of the roadway.
- Service laterals on *private* property – Tracer wire shall terminate at an approved Copperhead® single-terminal access point (when grounding isn’t required) affixed to or near the building exterior directly above where the utility enters the building, or at a two-terminal access point (when grounding is required) located within two linear feet of the building being served by the utility.
  - Single-terminal access points may include:
    - Above-grade, Cobra™ Access Point (T1-\*)
    - Above-grade, SnakeSkin™ Access Point (SNSK-\*-01)
    - At-grade, SnakePit® Lite Duty (LD14\*TP), Lite Duty Adjustable (LD14\*TP-ADJ), Lite Duty XL (LDXL36\*TP), or Concrete/Driveway (CD14\*TP) Access Point
  - Two-terminal access points may include:
    - Above-grade, Cobra™ Access Point (T2-\*)
    - At-grade SnakePit® Lite Duty (LD14\*2T), Lite Duty Adjustable (LD14\*2T-ADJ), Lite Duty XL (LDXL36\*2T), or Concrete/Driveway (CD14\*2T) Access Point
- Hydrants – Tracer wire shall terminate at an approved above-grade Copperhead Cobra™ Access Point properly affixed to the hydrant-grade flange (T2-\*-FLPKG-5/8 for hydrants with 5/8” bolts, and T2-\*-FLPKG-3/4 for hydrants with 3/4” bolts). Affixing with tape or plastic ties

shall not be acceptable. Tracer wire may also terminate at an approved at-grade Copperhead SnakePit® Lite Duty (LD14\*2T), Lite Duty Adjustable (LD14\*2T-ADJ), Lite Duty XL (LDXL36\*2T), or Concrete/Driveway (CD14\*2TP) Access Point.

- Long-runs, more than 2,500 linear feet, without service laterals or hydrants – Tracer wire access must be provided utilizing an approved at-grade Copperhead SnakePit® Access Point and grounded at dead-ends utilizing a drive-in magnesium Copperhead Ground Rod (ANO-12).

\* denotes color (B=blue, G=green, P=purple)

## Installation

### General

- Tracer wire installation shall be performed in such a manner that allows proper access for connection of line tracing equipment, proper locating of wire without loss or deterioration of low frequency (512 Hz) signal, and without distortion of signal caused by more than one wire being installed in close proximity to one another.
- Tracer wire systems must be installed as a single continuous wire, except where using approved connectors. No looping or coiling of wire is allowed.
- Any damage occurring during installation of the tracer wire must be immediately repaired by removing the damaged wire and installing a new section of wire with approved connectors. Taping and/or spray coating shall not be allowed.
- Tracer wire shall be installed at the bottom half of the pipe and secured (taped/tied) at 5-foot intervals.
- Mainline tracer wire shall not be connected to existing conductive pipes. Treat as a mainline dead-end ground using an approved waterproof connector to a Ground Rod driven into virgin soil beneath and in line with the utility.
- All service lateral tracer wire shall be a single wire, connected to the mainline tracer wire using a three-way mainline-to-service connector, installed without cutting/splicing the mainline tracer wire.
- In occurrences where an existing tracer wire is encountered on an existing utility that is being extended or tied into, the new tracer wire and existing tracer wire shall be connected using approved connectors.
- Tracer wire on all service laterals/stubs must terminate at an approved tracer wire access point located directly above the utility, at the edge of the road right-of-way, but out of the roadway.
- One foot of excess/slack wire is required in all tracer wire access points after meeting final elevation.
- Tracer wire must be properly grounded as specified.
- At all mainline dead-ends, tracer wire shall go to ground using an approved connection to a drive-in magnesium ground rod.
- When grounding the tracer wire at dead-ends/stubs, the Ground Rod shall be driven into virgin soil directly beneath and in line with the utility.
- Ground rod wire shall be connected to the ground rod terminal on the two-terminal SnakePit® Access Point Lid or to the bottom terminal on the two-terminal Cobra™ Access Point.

- Where the Ground Rod wire will be connected to a tracer wire access point, one foot of excess/slack wire is required after meeting final elevation.

### Sanitary Sewer System

- A mainline tracer wire must be installed, with all service lateral tracer wires properly connected to the mainline tracer wire, to promote tracing/locating capabilities from a single connection point.
- Lay mainline tracer wire continuously, by-passing around the outside of manholes/structures on the north or east side.
- Tracer wire on all sanitary service laterals must terminate at an approved tracer wire access point color coded green and located directly above the service lateral at the edge of road right-of-way.

### Water System

- A mainline tracer wire must be installed, with all service lateral tracer wires properly connected to the mainline tracer wire, to promote tracing/locating capabilities from a single connection point.
- Lay mainline tracer wire continuously, by-passing around the outside of valves and fittings on the north or east side.
- Tracer wire on all water service laterals must terminate at an approved tracer wire access point, color coded blue and located directly above the service lateral at the edge of road right-of-way.
- Tracer wire access points will be installed at all fire hydrants.
- All conductive and non-conductive service lines shall include tracer wire.

### Storm Sewer System

*This section shall be included at the discretion of the facility owner.*

- If the storm sewer system includes service laterals for connection of private drains and tile lines, it shall be specified the same as a sanitary sewer application.
- Lay mainline tracer wire continuously, by-passing around the outside of manholes/structures on the north or east side.

### Prohibited Products and Methods

The following products and methods shall NOT be allowed or acceptable:

- Uninsulated tracer wire
- Stainless steel tracer wire
- Tracer wire insulations other than HDPE
- Tracer wire not domestically manufactured
- Non-locking, friction fit or taped connectors
- Brass or copper ground rods
- Wire connections utilizing taping or spray-on waterproofing
- Looped wire or continuous wire installations that have more than one wire laid side-by-side or in close proximity to one another
- Tracer wire wrapped around the corresponding utility

- Brass fittings with tracer wire connection lugs
- Wire terminations within the roadway in valve boxes, cleanouts, manholes, etc.
- Connecting tracer wire to existing conductive utilities

## Testing

All new tracer wire installations shall be located using typical low frequency (512 Hz) line tracing equipment, witnessed by the contractor, engineer and facility owner as applicable, prior to acceptance of ownership.

This verification shall be performed upon completion of rough grading and again prior to final acceptance of the project.

Continuity testing in lieu of actual line tracing shall not be accepted.

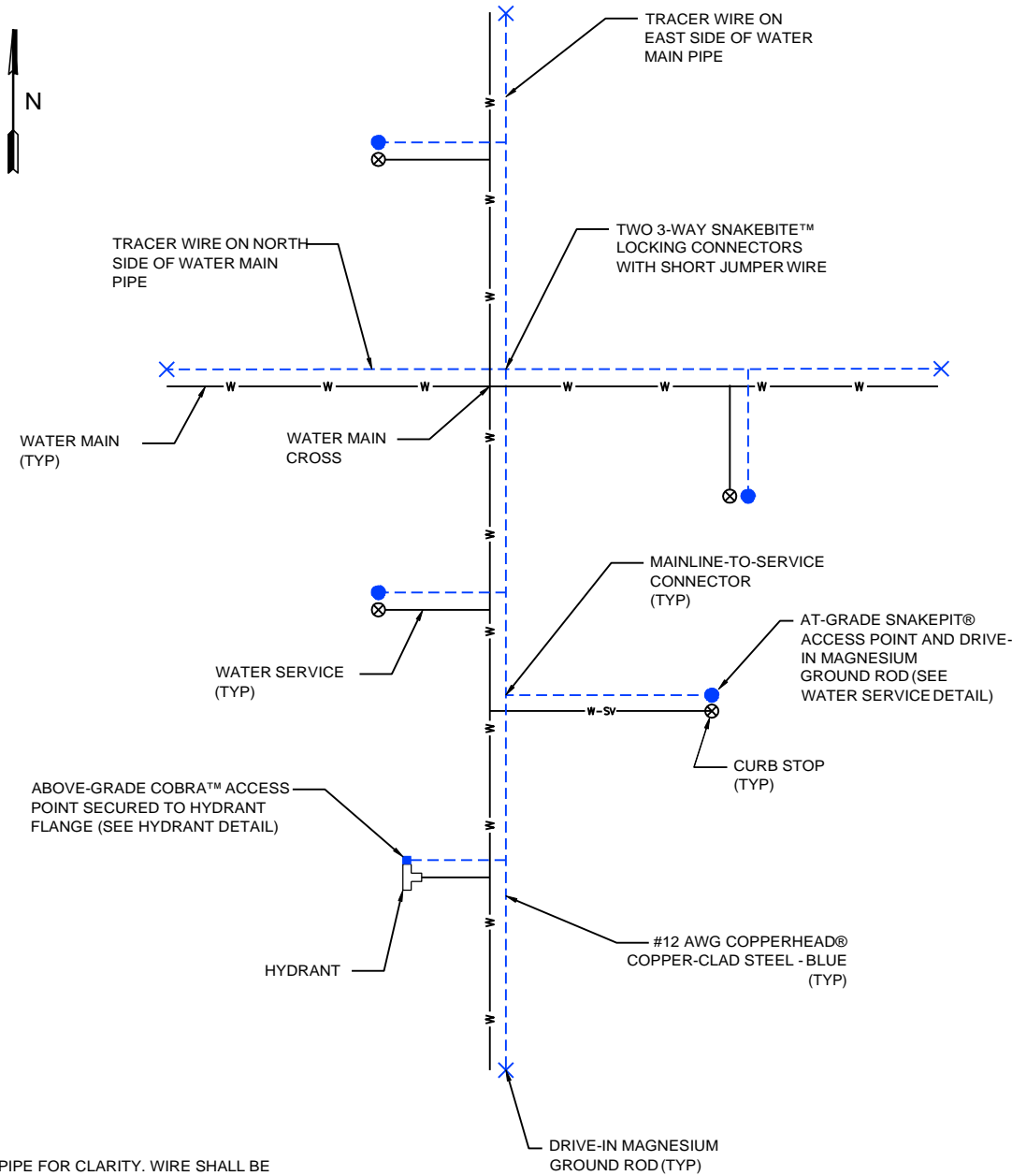

**NOTES:**  
 WIRE SHOWN AWAY FROM PIPE FOR CLARITY. WIRE SHALL BE INSTALLED ON THE BOTTOM SIDE OF THE PIPE BELOW THE SPRING LINE. THE WIRE SHALL BE FASTENED TO THE PIPE WITH TAPE OR PLASTIC TIES AT 5' INTERVALS.

**SAMPLE PLAN (WATER)**  
 NO SCALE



**COPPERHEAD INDUSTRIES**  
STANDARD DETAIL

---

COMPLETE UTILITY LOCATING SYSTEM™  
 SAMPLE PLAN (WATER)

June 29, 2018

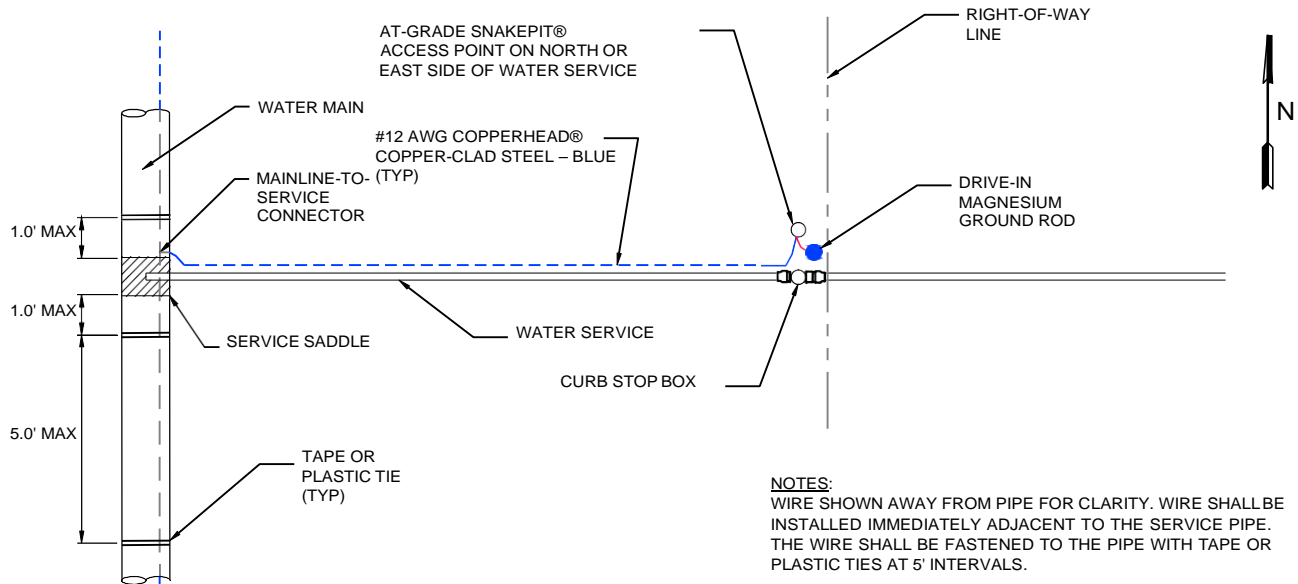

**WATER SERVICE - PLAN VIEW**

NO SCALE

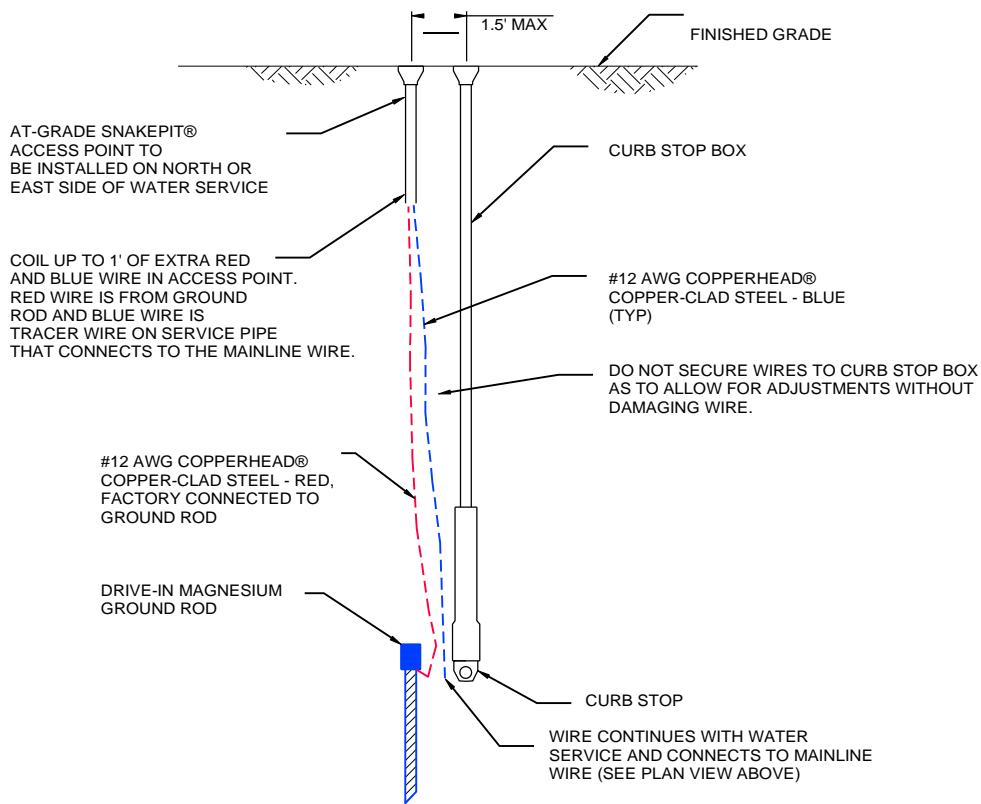

**WATER SERVICE - SECTION VIEW**

NO SCALE



COPPERHEAD INDUSTRIES  
STANDARD DETAIL

COMPLETE UTILITY LOCATING SYSTEM™  
WATER SERVICE DETAIL

June 29, 2018

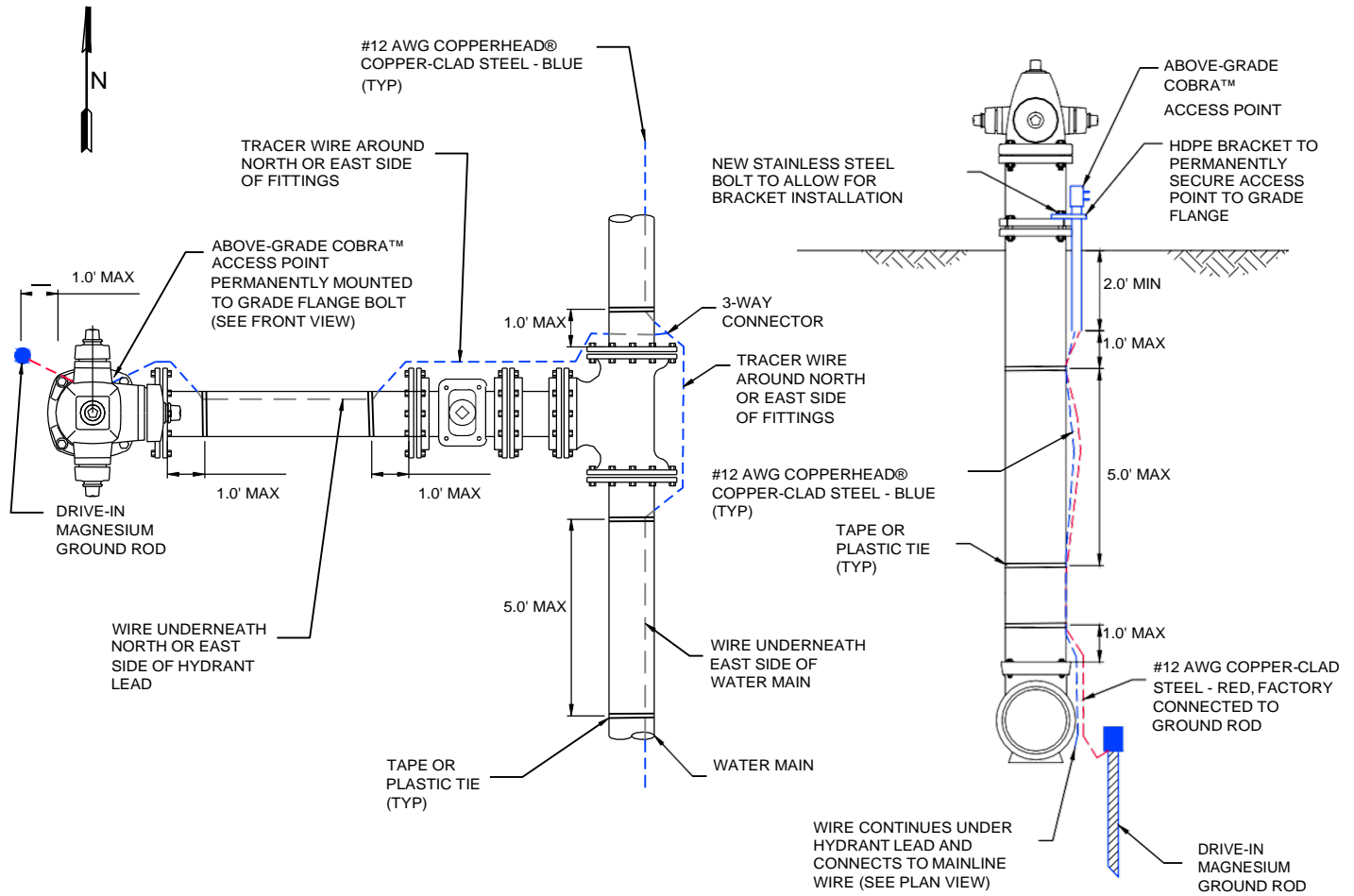

**HYDRANT - PLAN VIEW**  
NO SCALE

**HYDRANT - SECTION VIEW**  
NO SCALE



COPPERHEAD INDUSTRIES  
STANDARD DETAIL

COMPLETE UTILITY LOCATING SYSTEM™  
HYDRANT DETAIL

June 29, 2018



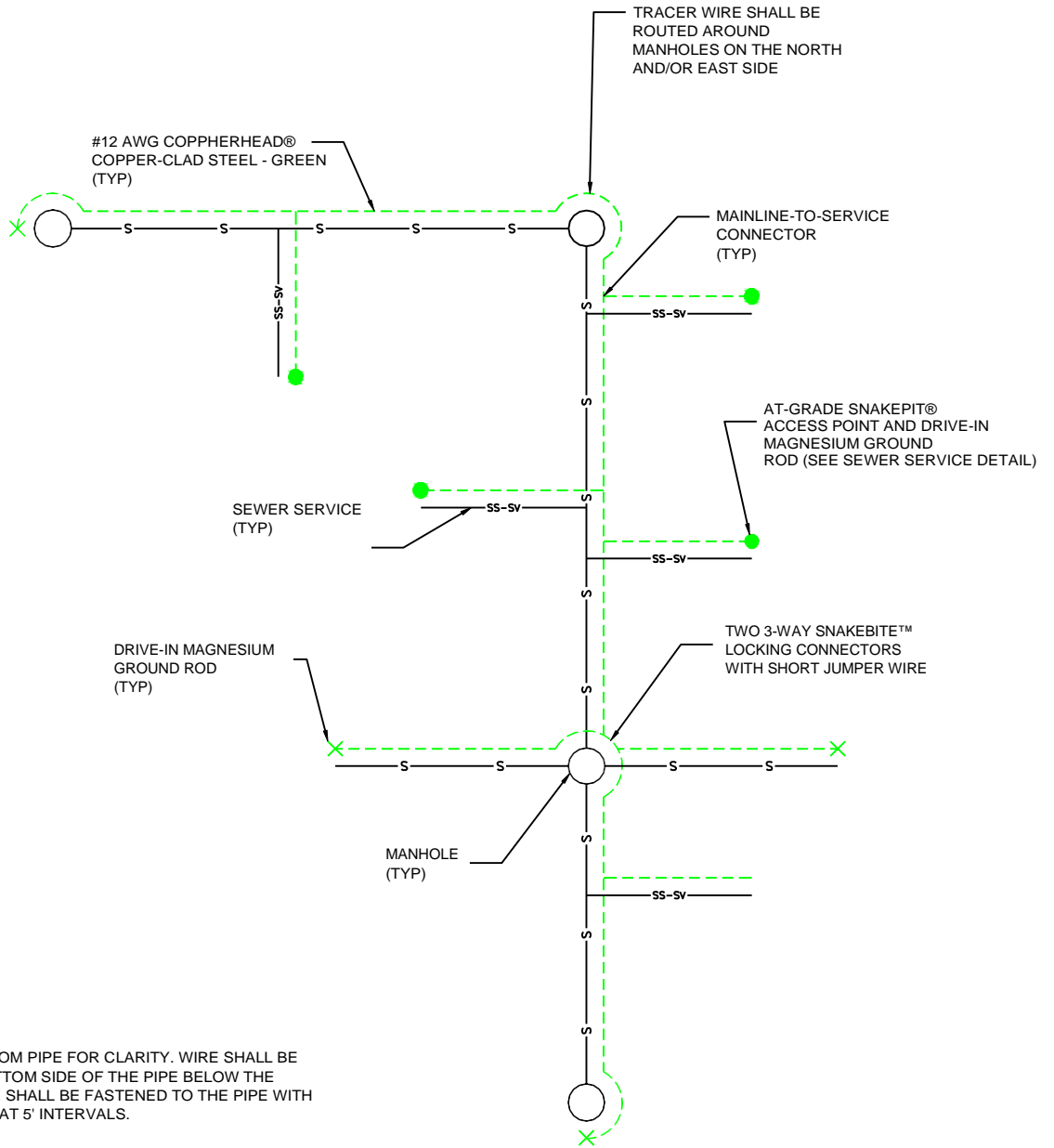
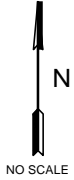

**NOTES:**  
 WIRE SHOWN AWAY FROM PIPE FOR CLARITY. WIRE SHALL BE INSTALLED ON THE BOTTOM SIDE OF THE PIPE BELOW THE SPRING LINE. THE WIRE SHALL BE FASTENED TO THE PIPE WITH TAPE OR PLASTIC TIES AT 5' INTERVALS.

**SAMPLE PLAN (SEWER)**

NO SCALE



COPPERHEAD INDUSTRIES  
 STANDARD DETAIL

COMPLETE UTILITY LOCATING SYSTEM™  
 SAMPLE PLAN (SEWER)

June 29, 2018

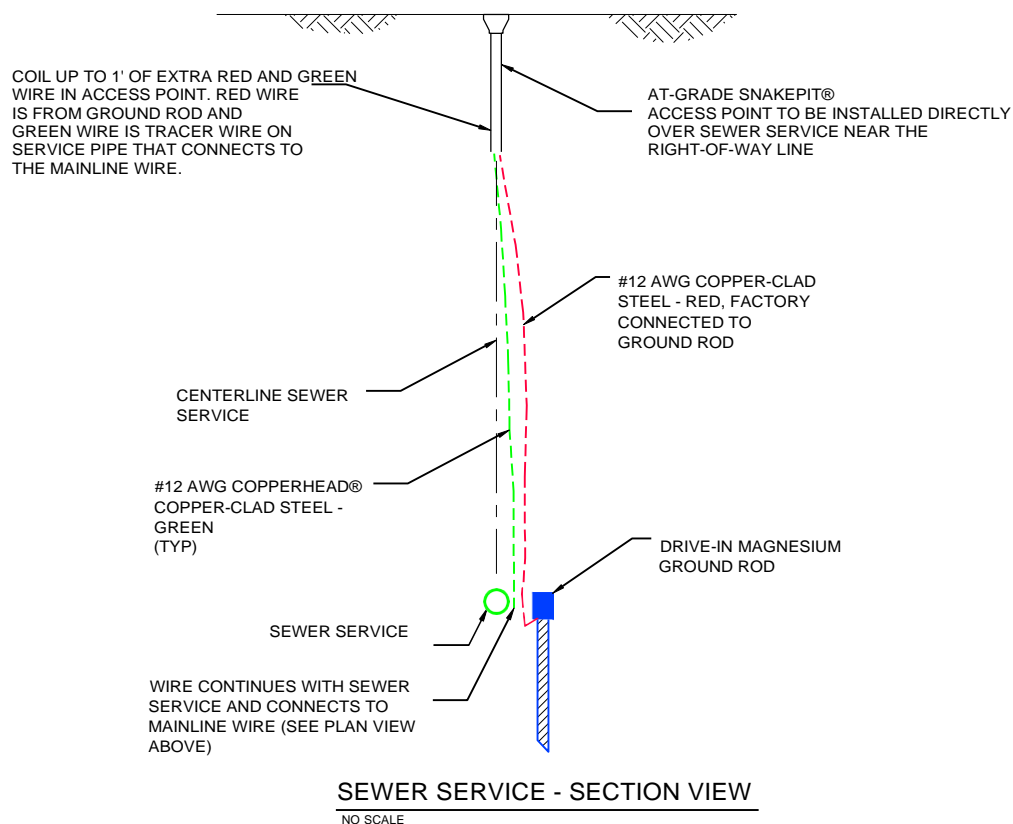
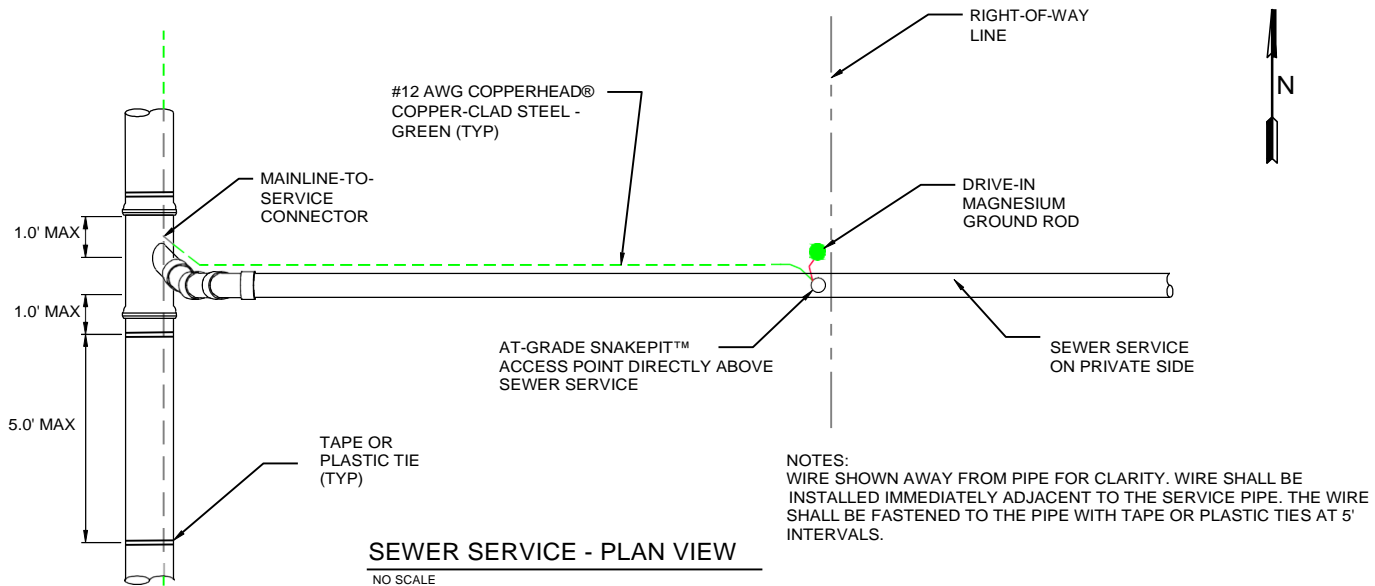

COPPERHEAD INDUSTRIES  
STANDARD DETAIL

COMPLETE UTILITY LOCATING SYSTEM™  
SEWER SERVICE DETAIL

June 29, 2018

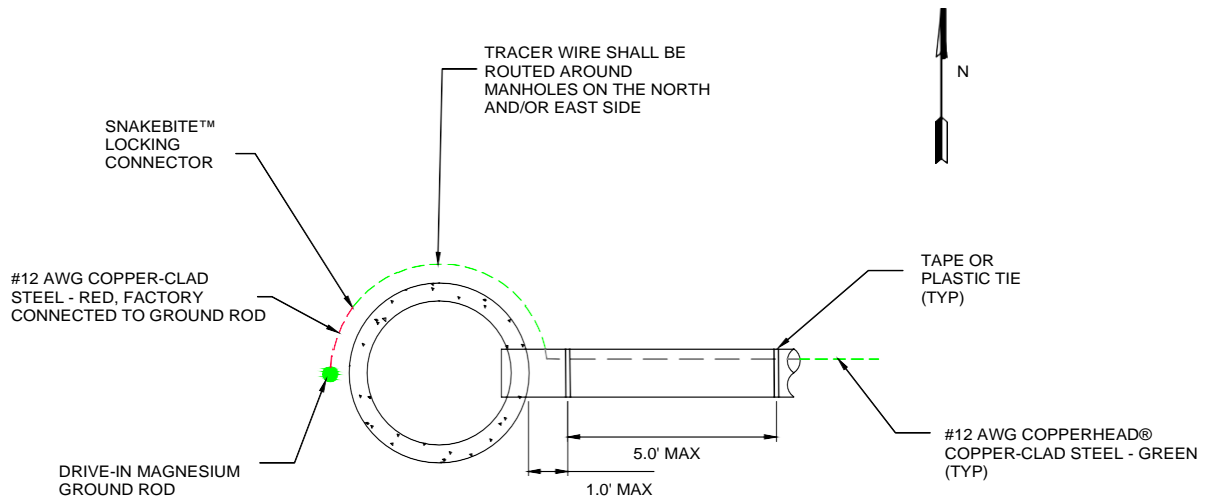

**SEWER MANHOLE - PLAN VIEW**

NO SCALE

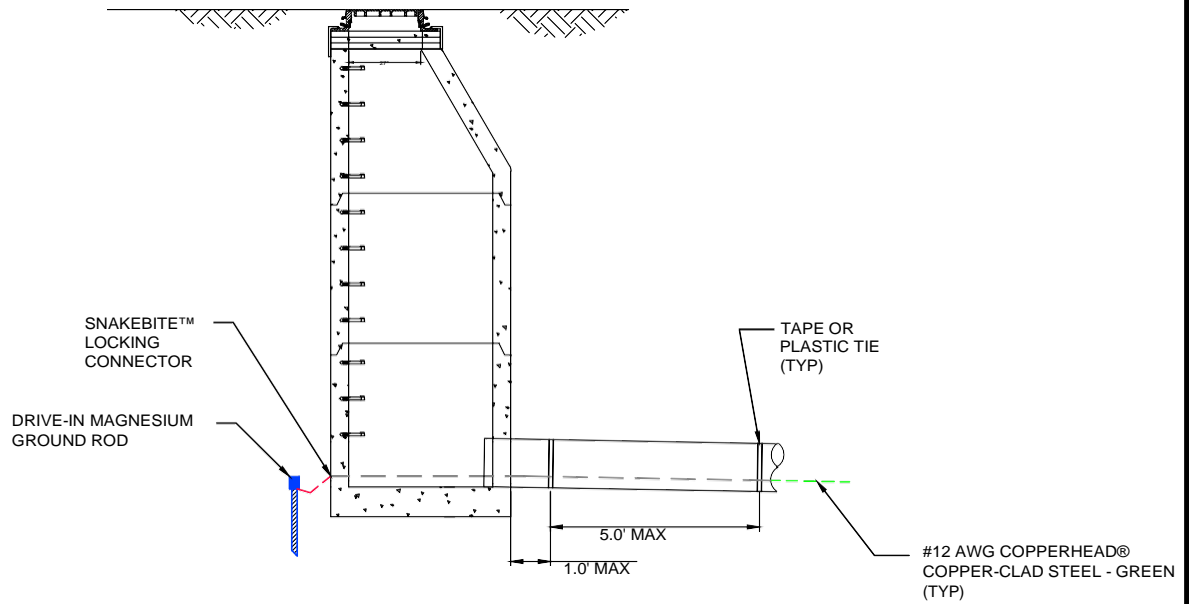

**SEWER MANHOLE - SECTION VIEW**

NO SCALE



COPPERHEAD INDUSTRIES  
STANDARD DETAIL

COMPLETE UTILITY LOCATING SYSTEM™  
SEWER MANHOLE DETAIL

June 29, 2018

THIS PAGE INTENTIONALLY BLANK





# The Complete Utility Locating System™ Specification Checklist

## TRACER WIRE

Verify Copperhead® copper-clad steel tracer wire by confirming that 'Copperhead®' is printed on wire (non-custom orders only).

 **High Strength, Open Cut**  
(1230\*-HS-\*\*)

 **Extra-High Strength, Directional Drill**  
(1245\*-EHS-\*\*)

 **SoloShot™ Xtreme, Pipe Bursting**  
(PBX\*-50-\*\*)

\*color (B-blue, G-green, P-purple) \*\*spool size (500', 1000', 2500')

## CONNECTORS

 **SnakeBite™ Locking Connector**  
(LSC1230C)

 **Mainline-to-Service Connector**  
(3WB-01)

## GROUNDING

 **Ground Rod** (ANO-12)

## LOCATING

Verify tracer wire installation can be located using low frequency (512 Hz) line tracing equipment.

## ACCESS POINTS





 **SnakePit® Lite Duty**  
Two-terminal *shown* (LD14\*2T)  
Single-terminal (LD14\*TP)

 **SnakePit® Lite Duty Adjustable**  
Two-terminal *shown* (LD14\*2T-ADJ)  
Single-terminal (LD14\*TP-ADJ)

 **SnakePit® Lite Duty XL**  
Two-terminal *shown* (LDXL36\*2T)  
Single-terminal (LDXL36\*TP)

 **SnakePit® Concrete/Driveway**  
Two-terminal *shown* (CD14\*2T)  
Single-terminal (CD14\*TP)

 **Cobra™**  
Two-terminal *shown* (T2-\*)  
Single-terminal (T1-\*)

 **Cobra™ Hydrant Flange Package**  
5/8" bolts (T2-\*FLPKG-5/8)  
3/4" bolts (T2-\*FLPKG-3/4)

 **SnakeSkin™** (SNSK-\*-01)

